

4000 GALLON GREASE INTERCEPTOR (816)

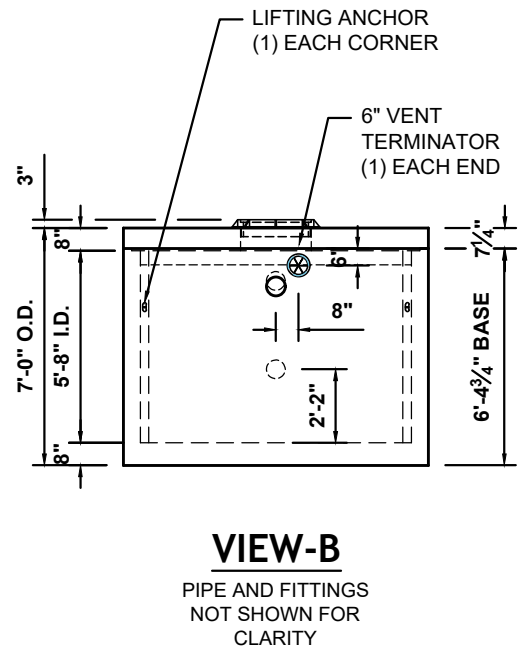

NOTES:

- Maximum DFU's = 428 for 4,000 gallon size Interceptor.
- Heaviest pick weight = approx. 39,810lbs.
- Vault meets or exceeds ASTM-C1613 & IAPMO/ANSI Z1001.
- H20 Traffic Rated.
- Fill completely with clean water prior to start-up of system.
- Gray water only.
- Ventilate Interceptor before servicing.
- It is the responsibility of the owner to service this unit.
- Interior plumbing included.
- Grade rings available as needed.

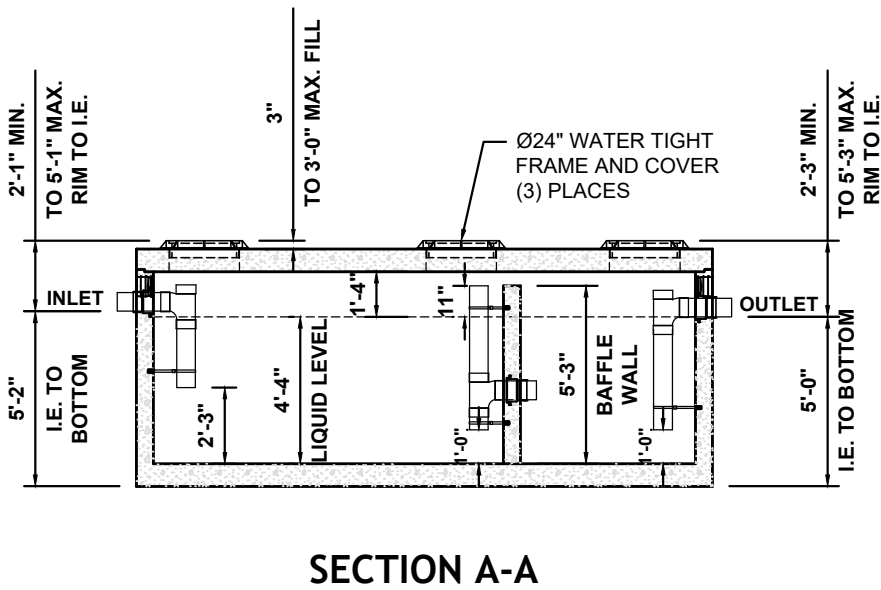
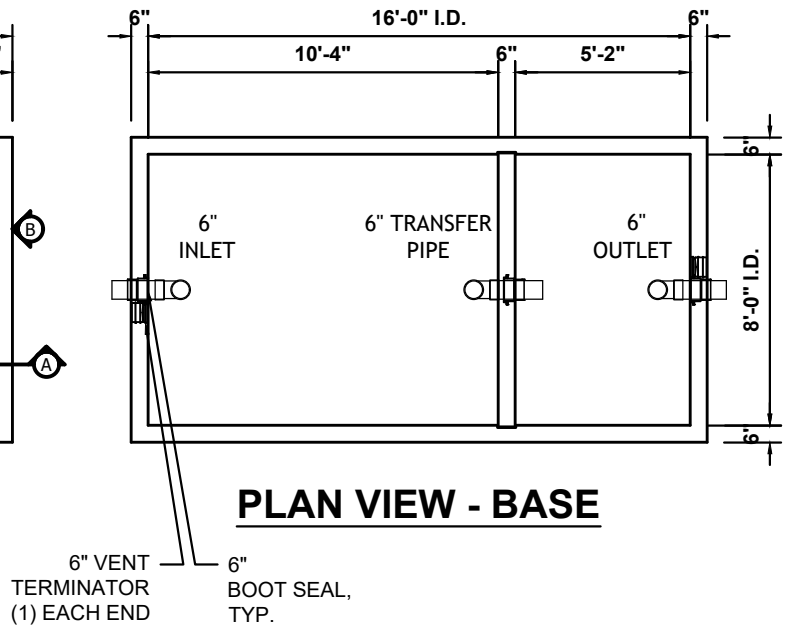
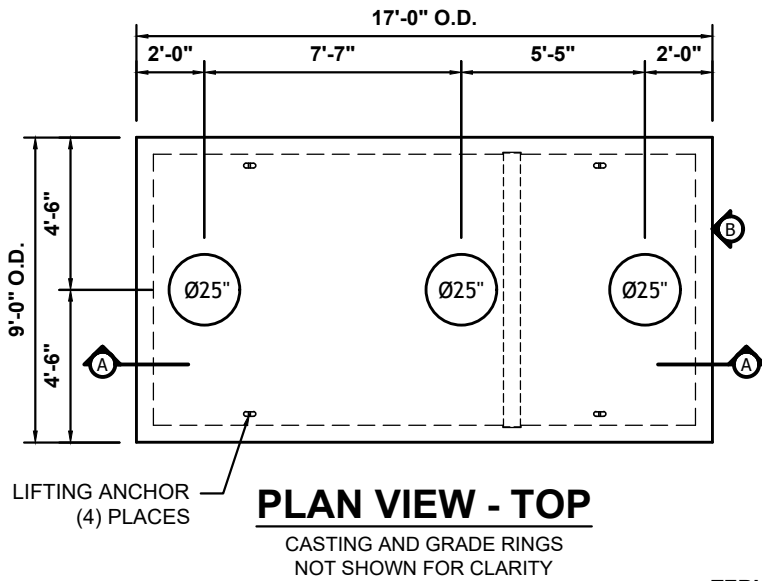

"IAPMO Listed"