

# 2000 GALLON GREASE INTERCEPTOR (687)

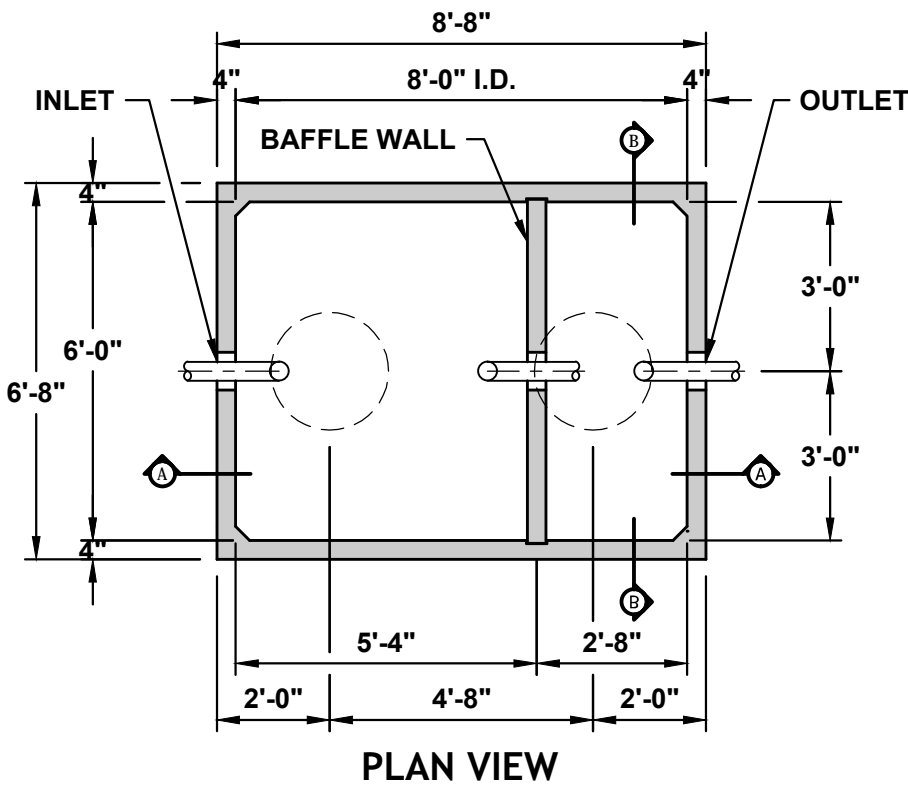
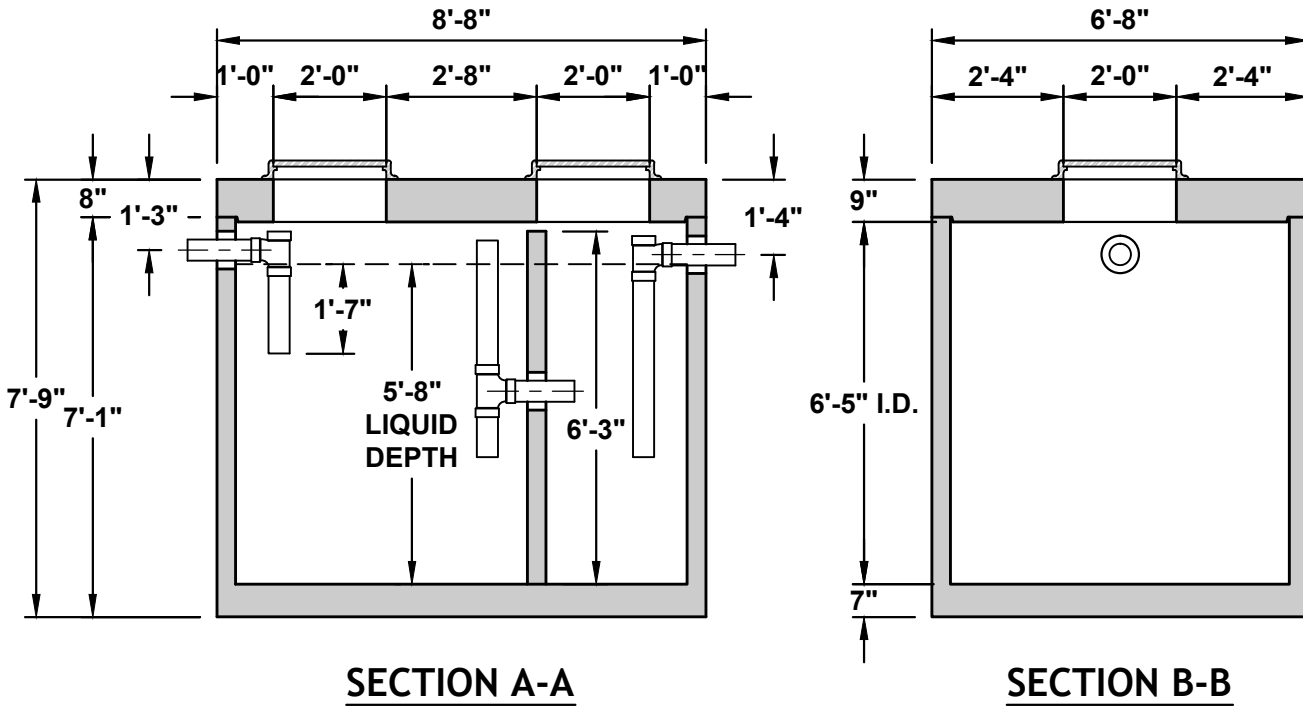

**NOTES:**

1. HEAVIEST PICK WEIGHT = 16,000LBS.
2. VAULT MEETS OR EXCEEDS ASTM-C857 & H20-44.
3. CONTRACTOR TO GROUT PVC PIPE PENETRATIONS.
4. CONTRACTOR TO GROUT IN BAFFLE WALL.
5. CONTRACTOR TO SUPPLY & INSTALL PIPE IN FIELD.